

Isolated pH 1 Circuit

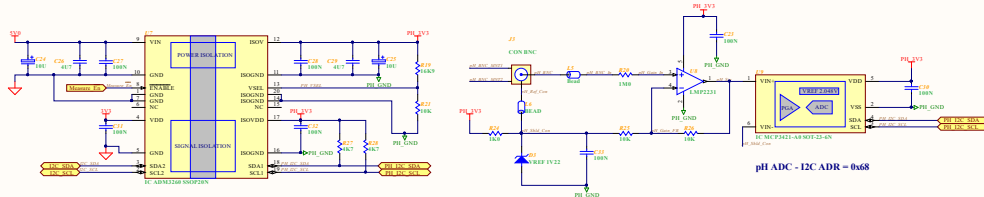

Isolated pH 2 Circuit

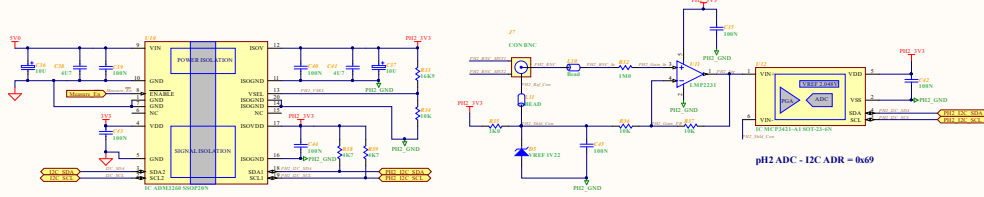

Isolated Moisture Circuit

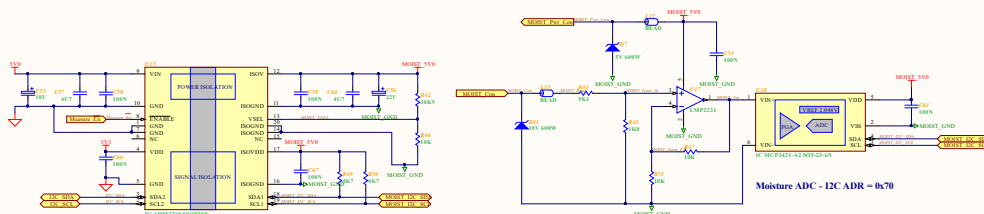

Tipping Bucket 1 Circuit

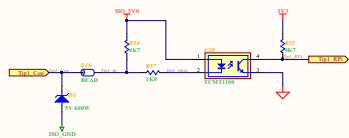

Tipping Bucket 2 Circuit

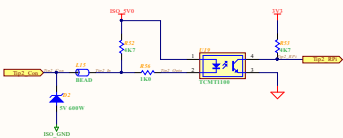

Connectors

Raspberry Pi

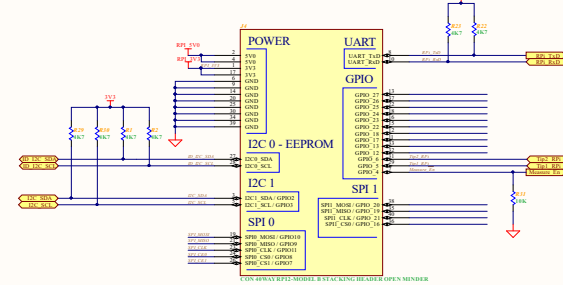

Measurement

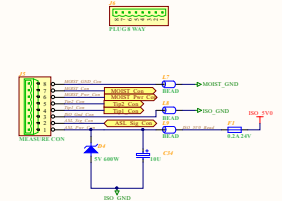

ASL Bus Circuit

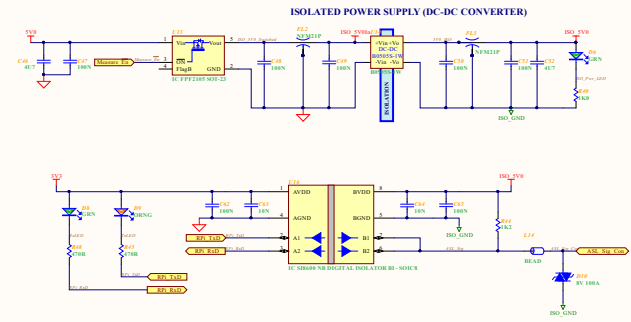

Power Filtering

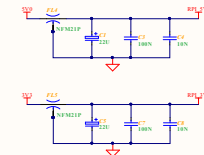

Hat EEPROM

